

INDEX

	PAG.
I.- IMPORTANT SAFETY INSTRUCTIONS	3
II.- WARNING	3
III.- FEATURES	4
IV.- HOW TO ASSEMBLE THE PAD	4
V.- HOW TO REPLACE RUBBER ISOLATORS (SHOCK ABSORBES)	4
VI.- FAILURES AND CORRECTIONS	5
VII.- HANDLE PARTS	6
VIII.- HANDLE PARTS LIST	7
IX.- ASSEMBLY MOTOR AND CHASSIS PARTS	8
X.- ASSEMBLY MOTOR AND CHASSIS PARTS LIST	9
XI.- PAD PARTS	10
XII.- PAD PARTS LIST	11



WHEN USING A FLOOR MACHINE, BASIC PRECAUTIONS SHOULD BE FOLLOWED, INCLUDING THE FOLLOWING:
 READ ALL INSTRUCTIONS BEFORE USING THE FLOOR MACHINE.

II. - WARNING

To reduce risk of fire, electric shock or injury:

- “WARNING OF POTENTIAL INJURY”. The floor machine contains moving parts, be sure to unplug the machine before servicing to reduce the risk of injury.
- Do not put any objects into openings.
- Keep hair, loose clothing, fingers, and all parts of body away from openings and moving parts.
- Never turn the appliance on with the handle in the upright position. Make sure the handle is in operating position.
- Do not leave machine unattended when plugged in. Unplug the electrical cord when not in use or before servicing.
- Use only accessories recommended by Koblenz
- Do not use with damaged cord or plug.
- Do not pull or carry by cord, use cord as handle, close a door on cord, or pull a cord around sharp edges or corners. Do not run floor machine over cord. Keep cord away from heated surfaces.
- Verify if local voltage is 120 V~

THESE MODELS ARE GROUNDED; CONNECT TO A PROPERLY GROUNDED OUTLET ONLY-SEE.

GROUNDIRG INSTRUCTIONS.

General: this floor-finishing machine shall be grounded while in use to protect the operator from electric shock. The machine is provided with a three-conductor cord and a three-contact grounding type attachment plug to fit the proper grounding type receptacle. Then green (or green and yellow) conductor in the cord is the grounding wire. Never connect this wire to other than the grounding pin of the attachment plug.

WARNING: Improper connection of the equipment-grounding conductor can result in a risk of electric shock, Check that the contact you will this properly grounded. Do not modify the plug provided with the appliance, if plug will not fit the outlet, install one according to the pin of the device.

This machine is for use on nominal 120 V~ circuit and has grounding plug that resembles the plug illustrated in sketch A, Make sure that machine is connected to an outlet having the same configuration as the plug. No adapter should be used with this machine.

Note: In Canada, the use of temporary adapter is not permitted by the Canadian Electrical Code.

Warning: The power cord on this product contains lead, a chemical know to State of California cause birth defects reproductive harm. WASH HANDS AFTHET HANDLING

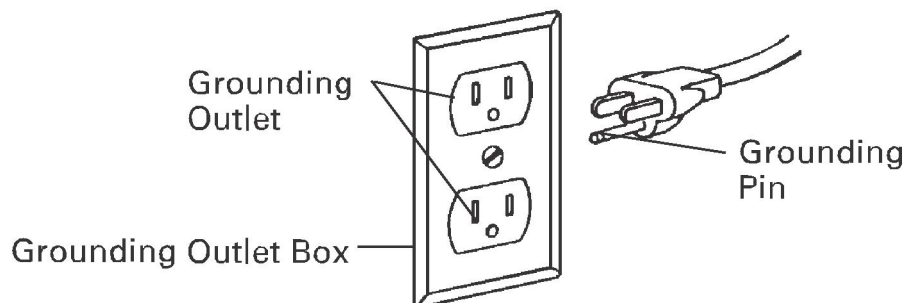

III. - FEATURURES

MODEL	V~	A	Hz
SP-15	120	9	60

IV. - HOW TO ASSEMBLE THE PAD

Always unplug the machine before installing any accessory.

1. Unplug machine, secure handle tube in vertical position and lay down the machine turning it over wheels until the underneath side of the machine is vertical and fully exposed.
2. Before laying down machine, place a clean towel on the floor to keep the Switch box from scratching.
3. Install or replace pad. The pad should be replaced if it has become matted down to thickness of 3/8" or less.
4. Remove existing pad then center new pad over grip face. Press pad against grip face until the hooks in the driver have set in the pad.
5. Return the machine to the upright position.
6. Do not operate this machine with out the pad in place.
7. Always leave a pad on the machine to protect the grip face from damage.

V.-HOW TO REPLACE RUBBER ISOLATORS(SHOCK ABSORBERS).

This unit works with 4 rubber isolators (shock absorbers) that reduce the vibration of the floor machine during operation. If the unit vibrates or makes more noise than usual, then the replacement of the shock absorbers may be necessary.

1. Always unplug the machine before replacing any part.
2. Follow instructions 1 & 2 on how to assemble the pad.
3. Remove the central part of the grip face pulling it off the pad driver.
4. Remove the central screw on the bottom of the pad driver with a 3/4 wrench (Fig. 1).
Note: To unscrew the central screw, you can use a screw driver to block the fan on top of the motor (Fig. 2) this will hold the screw from spinning.
5. Remove the 4 screws that hold the pad driver with the chassis. (Fig.3).
6. Unscrew the 4 rubber isolators(shock absorbers) and replace with new ones (Fig. 4)
7. Follow the same instructions in reserve to reassemble the unit.

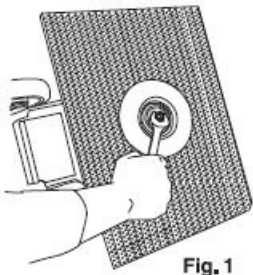

Fig. 1

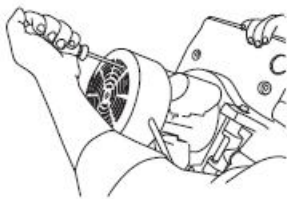

Fig. 2

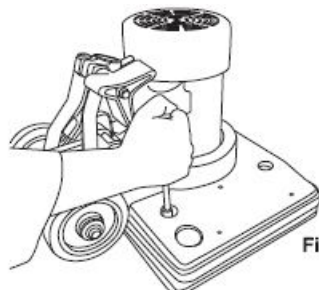

Fig. 3

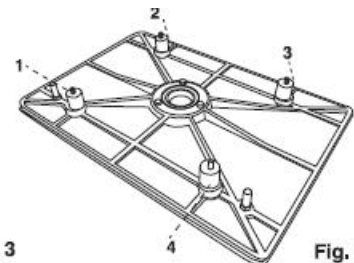
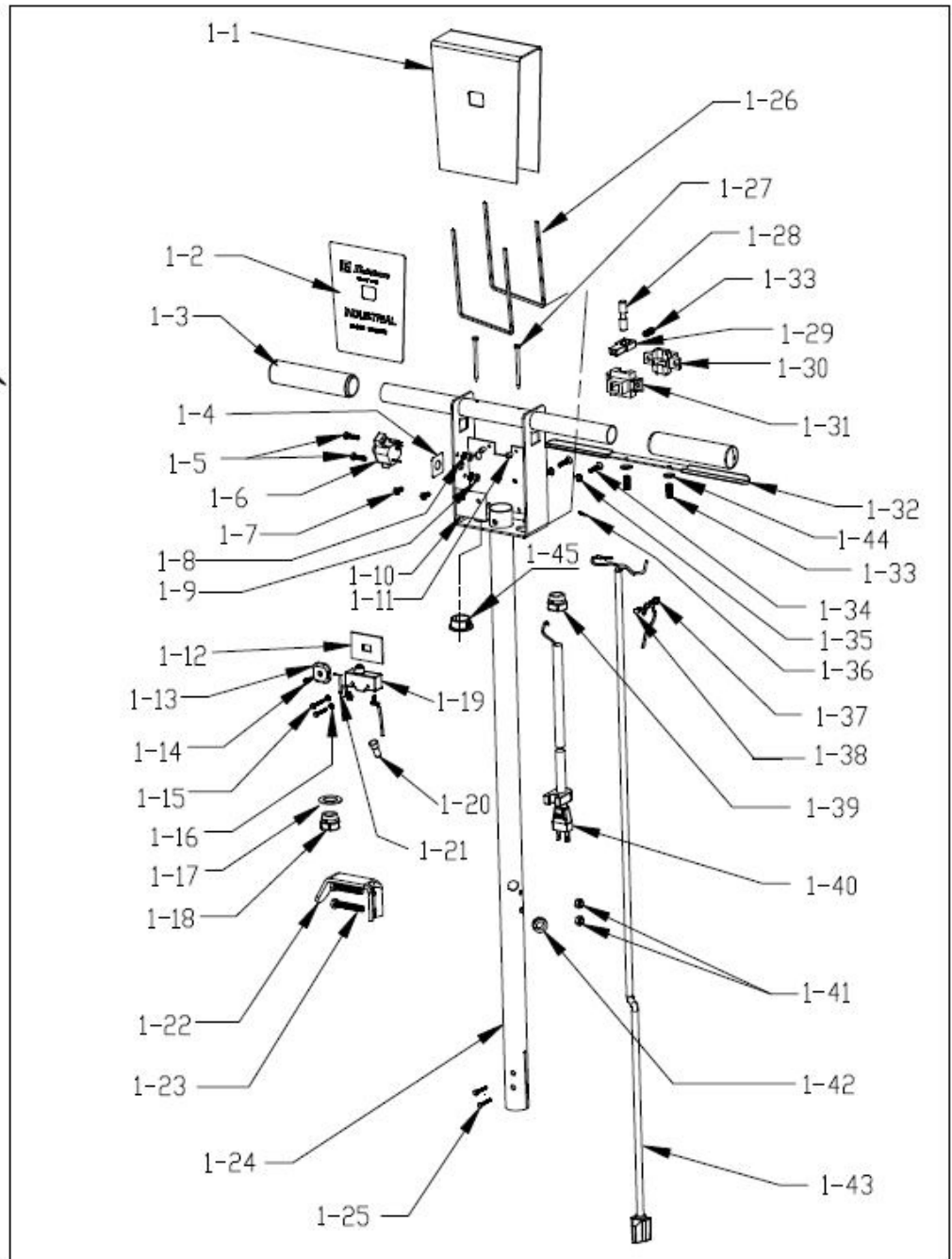

Fig. 4

VI. -FAILURES AND CORRECTIONS.

FAILS	POSSIBLE CAUSE	SOLUTION
MOTOR DOESN'T START	CONNECTED	CHECK CONETION
	LINE CORD DAMAGE	REPLACE
	LINE CORD UNPROPERLY CONNECTED	CHECK CONNECTION
	LINE CORD DAMAGED	CHECK LINE CORD
	MICROSWITCH DAMAGED	REPLACE MICROSWITCH
	MOTOR LINE CORD DAMAGED	REPLACE MOTOR LINE CORD
	MOTOR ASSEMBLY DAMAGED	REPLACE MOTOR ASSEMBLY
	SAFETY KNOB NOT POSITIONED	POSITION SAFETY RELASE
MOTOR WORKS BADLY	LOW VOLTAGE	CHECK VOLTAGE (LINE 120 V~)
	CAPACITOR DAMAGED	REPLACE CAPACITOR
	UNPROPER MOTOR CONNECTIONS	CHECK CONNECTIONS

1



VIII. - HANDLE PARTS LIST

ITEM	No. PARTE	DESCRIPTION	QUANTITY
1	46-3168-00-2	HANDLE ASSEMBLY	1
1-1	05-3975-9	HANDLE COVER	1
1-2	17-3782-4	HANDLE LABEL	1
1-3	12-0830-5	HANDLE GRIP	2
1-4	17-3677-6	RESET LABEL	1
1-5	01-1256-5	BOLT 10-24 X 3/4	2
1-6	38-0338-4	CIRCUIT BREAKER 20 A	1
1-7	01-1732-5	SCREW 8-32X1/2"	2
1-8	04-0271-9	STAR WASHER	2
1-9	02-0015-4	HEX NUT 10-24 NC	2
1-10	08-1857-5	SWITCH INSULATION	1
1-11	05-3536-9	SWICTH ACTUATOR SPACER	2
1-12	37-0225-5	DUST CONTROL GASKET	1
1-13	13-2209-8	SECURITY LOCK	1
1-14	01-0272-3	SCREW 6X1/2	1
1-15	01-0851-4	BOLT 6-32 X 1	2
1-16	04-0275-0	STAR WASHER .140/.145X.310X.020	2
1-17	04-0036-6	FLAT WASHER 3/4 X 1-1/4	1
1-18	12-0414-8	STAIN RELIEVE No 1244	1
1-19	11-0096-5	MOMENTARY SWITCH	1
1-20	10-0140-3	CONNECTOR	1
1-21	28-0958-0	SWITCH CABLE ASSEMBLY	1
1-22	05-4275-3	CORD HOOK	1
1-23	01-0870-4	BOLT 1/4-20X 1 3/4	2
1-24	23-0982-00-1	HANDLE ASSEMBLY	1
1-25	01-1769-7	BOLT 1/4-20X 1 1/4	2
1-26	12-0869-01-1	HANDLE GASKET	2
1-27	03-0593-8	NAIL GAUGE 9 LENGTH 2 1/2"	2
1-28	13-2205-6	SECURITY LOCK PISTON	1
1-29	13-2206-4	SECURITY LOCK BUTTON	1
1-30	13-2207-4	SECURITY LOCK HOUSING	1
1-31	13-2208-0	SECURITY LOCK COVER	1
1-32	05-3979-1	ON/OFF LEVER	1
1-33	24-0292-3	LEVER SPRING	3
1-34	01-1984-2	BOLT 8-32X7/8	2
1-35	04-0276-8	STAR WASHER No. 8	2
1-36	17-3988-7	NEUTRAL LABER	1
1-37	04-0493-9	INTERNAL TOOTH WASHER	1
1-38	01-0852-2	BOLT 8-32 X 3/8	1
1-39	12-0313-2	STRAIN RELIEVE 1274	1
1-40	28-1078-6	LINE CORD	1
1-41	02-0092-3	NYLON NUT	4
1-42	12-0115-1	RUBBER STRAIN RELIEVE	1
1-43	28-0672-7	MOTOR LINE CORD	1
1-44	04-0019-1	FLAT WASHER	2
1-45	12-1167-00-5	HEYCO CAP 2683	1

IX.-ASSEMBLY MOTOR AND CHASSIS PARTS

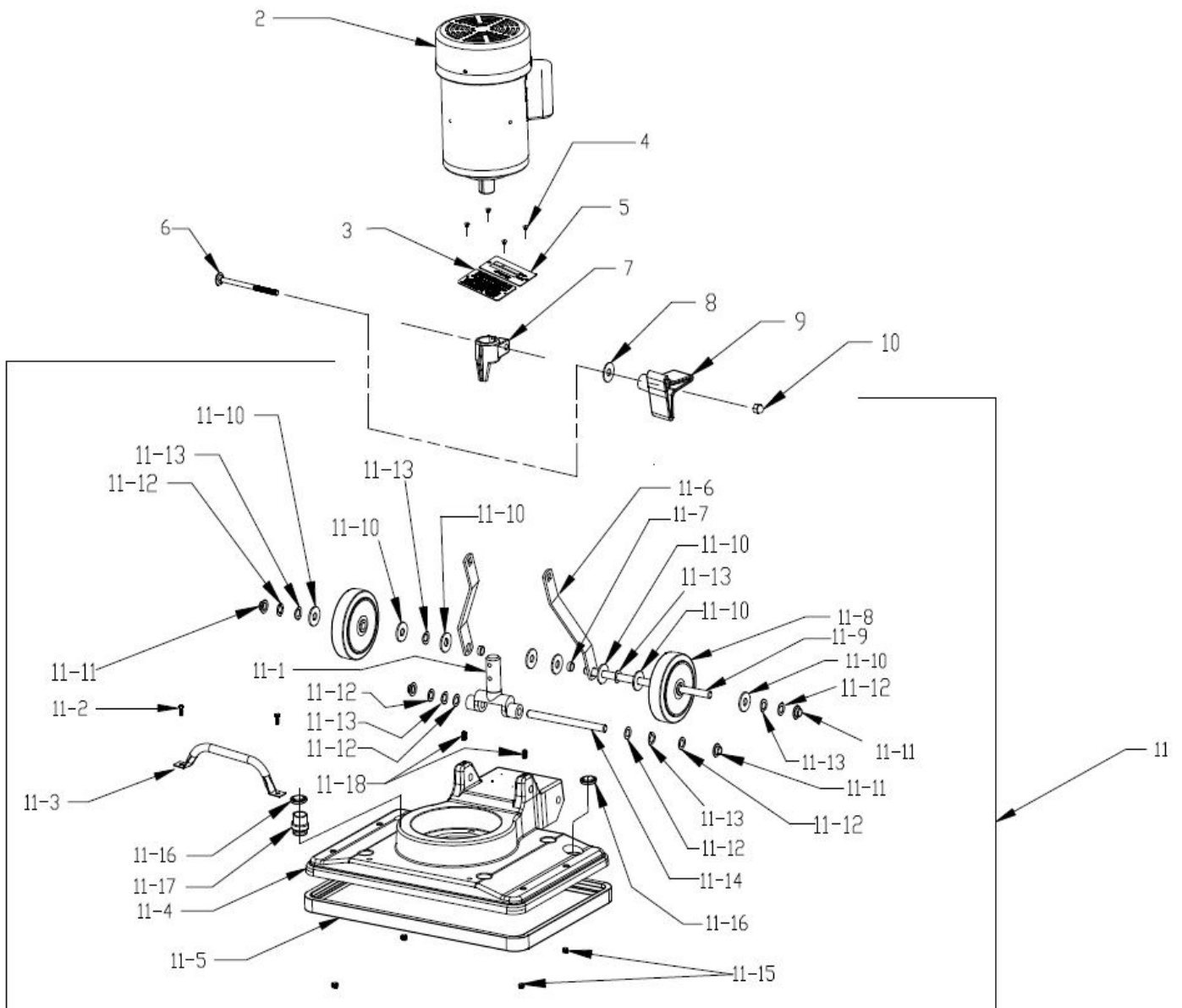

X. - ASSEMBLY MOTOR AND CHASSIS PARTS LIST.

ITEM	No. PARTE	DESCRIPTION	QUANTITY
2	46-3774-00-0	MOTOR ASSEMBLY	1
3	17-3550-5	CAUTION PLATE	1
4	03-0119-2	RIVET "U" TYPE # 4	4
5	17-5928-00-1	SPECIFICATION PLATE	1
6	01-1746-5	STEP BOLT 3/8	1
7	06-0404-01-1	PIPE CLAMP POSITION	1
8	04-0073-9	PRESSURE WASHER 3/8	1
9	06-0865-3	KNOB	1
10	02-0119-4	ACORN CAP 1/4-20 NC	1
11	46-3766-00-6	CHASSIS ASSEMBLY	1
11-1	06-0771-3	YOKE	1
11-2	01-1171-3	BOLT 5/16 X 1	2
11-3	05-5591-01-0	CHASSIS HANDLE	1
11-4	06-1018-02-4	CHASSIS	1
11-5	12-1158-00-0	BUMPER	1
11-6	05-1975-1	BRACE	2
11-7	25-1210-1	BUSHING BRACE	2
11-8	45-0573-1	WHEEL	2
11-9	25-1314-01-9	WHEEL SHAFT	1
11-10	04-0074-7	FLAT WASHER ½	8
11-11	04-0671-01-8	CAP NUT ½	4
11-12	04-0545-6	STAINLESS STEEL FLAT WASHER	6
11-13	04-0397-2	SPRING WASHER	6
11-14	25-1314-02-7	YOKE SHAFT	1
11-15	01-1006-4	ALLEN SET 5/16 X 5/6	4
11-16	13-0064-01-7	CHASSIS CAP	2
11-17	12-1165-00-5	DUST CONTROL COUPLING	1
11-18	01-2106-1	ALLEN SET ¼ X ½	2

XI. - PAD PARTS

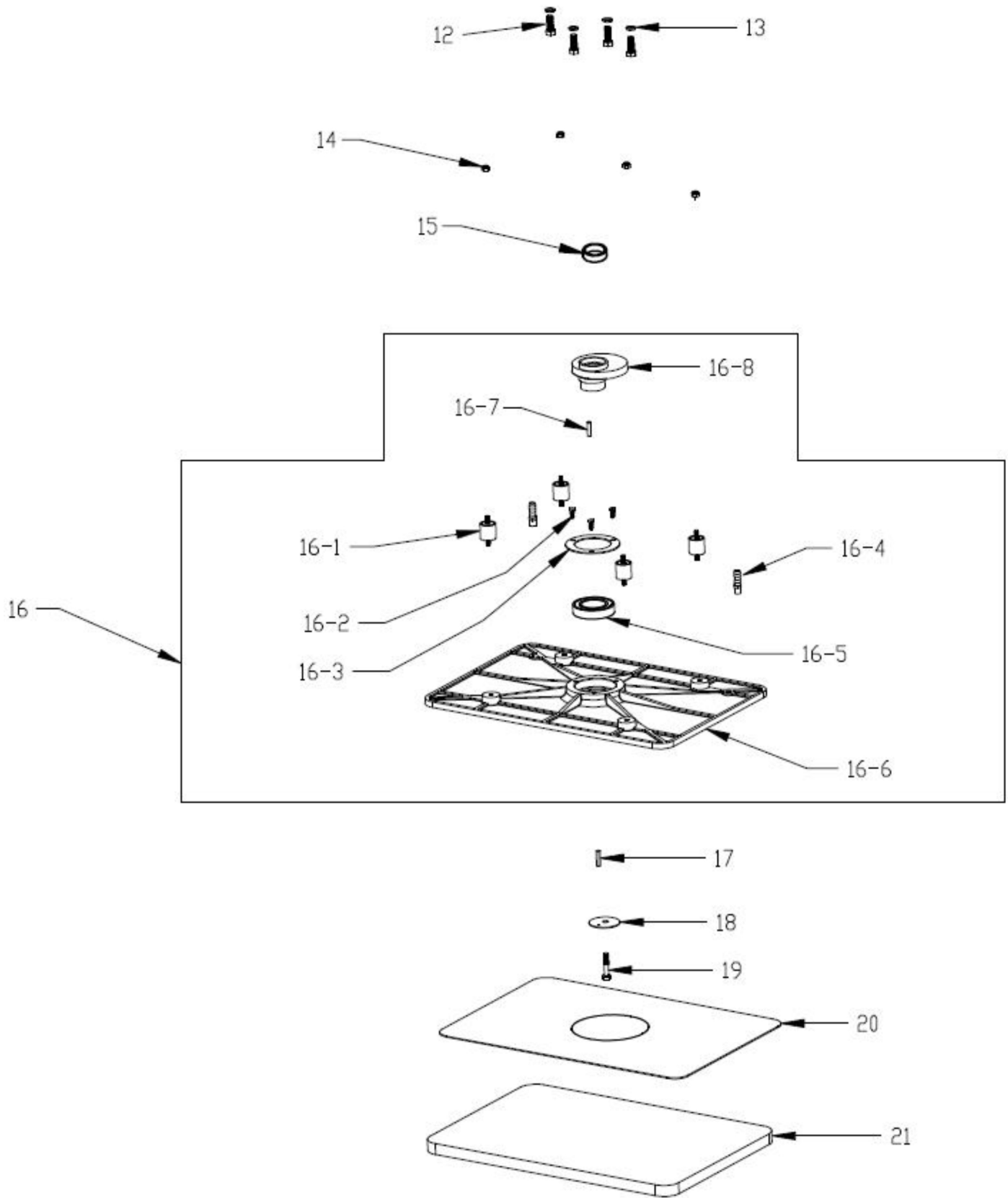

XII. - PAD PARTS LIST

ITEM	No. PARTE	DESCRIPTION	QUANTITY
12	01-1773-9	BOLT 3/8 X 1	4
13	04-0142-2	PRESSURE WASHER 3/8	4
14	02-0092-3	NYLON NUT	4
15	25-1495-01-6	MOTOR SPACER	1
16	46-3767-00-4	PAD DRIVER ASSEMBLY	1
16-1	12-1159-00-8	SHOCK ABSORBER	4
16-2	01-0873-8	BOLT 1/4-20 X 1/2	3
16-3	05-5585-00-01-2	BEARING RETAINER	1
16-4	27-0658-00-8	BARBED HOSE 1/8 NPT	2
16-5	26-0260-01-3	BEARING 6008 LU	1
16-6	06-1019-01-4	PAD DRIVER	1
16-7	25-1369-5	SPIROL PIN	1
16-8	06-1021-01-0	ORBITAL WEIGHT	1
17	25-0024-7	WEDGE 3/16 X 1 "	1
18	05-5586-01-0	PAD DRIVER WASHER	1
19	01-1777-0	BOLT 5/16 X 1-1/2	1
20	12-1160-00-6	FACING GRIP	1
21	37-0360-00-0	PAD	1
**	19-0845-00-8	USER MANUAL	1
OPTIONAL ACCESSORIES			
**	45-0865-0	4 GALLON TANK	
**	45-0865-1	22 Lb WEIGHT	
**	45-0864-4	PAD KIT	
**	45-0867-7	SHOCK ABSORBERS KIT	

** NOT ILLUSTRATED.